

Eaton® Bypass Power Module (BPM)

User's Guide

For use with the following:

- Eaton 9155 UPS (8–15 kVA)
- Eaton 9170+ UPS (3–18 kVA)
- Eaton 9PX Split-Phase UPS (6–10 kVA)



Powering Business Worldwide

Special Symbols

The following are examples of symbols used on the UPS or accessories to alert you to important information:



RISK OF ELECTRIC SHOCK - Observe the warning associated with the risk of electric shock symbol.



CAUTION: REFER TO OPERATOR'S MANUAL - Refer to your operator's manual for additional information, such as important operating and maintenance instructions.



This symbol indicates that you should not discard the UPS or the UPS batteries in the trash. This product contains sealed, lead-acid batteries and must be disposed of properly. For more information, contact your local recycling/reuse or hazardous waste center.



This symbol indicates that you should not discard waste electrical or electronic equipment (WEEE) in the trash. For proper disposal, contact your local recycling/reuse or hazardous waste center.

Eaton is a registered trademark of Eaton. All other trademarks are properties of their respective companies.

©Copyright 2017 Eaton, Raleigh NC, USA. All rights reserved. No part of this document may be reproduced in any way without the express written approval of Eaton.

Table of Contents

1	INTRODUCTION	1
	Bypass Overview	1
2	INSTALLATION	3
	Bypass Power Module Dimensions	4
	Rackmount Installation	5
	125A BPM Rackmount Hardwired Installation	5
	30A Linecord Input BPM Rackmount Installation	7
	Wallmount Installation	8
	Wallmount Hardwired BPM Installation	8
	30A Wallmount Linecord BPM Installation	10
	Input Current and Wire Ratings	11
	Signal Wire Routing	11
	Connection Diagrams	13
3	OPERATION	17
	No Break Transfer from UPS Mode to Service Mode	17
	Lock-out/Tag-out	18
	No Break Transfer from Service Bypass to UPS Mode	18
4	SPECIFICATIONS	21
	Rear Panel Outlet Options	22

Table of Contents

Chapter 1 Introduction

The Eaton® Bypass Power Module (BPM) is designed to be a maintenance bypass switch that also contains flexible output power distribution and mounting options. The BPM is a bypass module that can be used with a variety of Eaton UPS models including the 9170+, 9155, and 9PX SP.

The BPM provides added reliability to Eaton uninterruptible power supply (UPS) systems by ensuring seamless, uninterrupted, no-break transfer as well as a lock-out/tag-out (LOTO) feature to ensure the greatest safety for UPS technicians and electricians. The BPM also offers output distribution in order to simplify wiring in a rackmount IT environment, potentially removing the need for a panelboard, breakers, and conduit for distribution.

Although the BPM is designed to be safe, the bypass can carry high levels of voltage and current. The BPM should only be operated by an experienced user, familiar with UPS behavior and functionality. Installation for models requiring hardwire connections should be performed by a qualified electrician following local electrical codes. Please refer to the installation chapter of your UPS manual for the BPM wiring diagram.

Bypass Overview

The BPM has three operating positions (see Table 1). Failure to understand the correct bypass sequence and position may cause the critical load to be dropped. Consider both the operating state of the UPS and the BPM when protecting your critical loads.

**NOTE**

In the UPS or LINE position, AC input power is still connected to the input terminals inside the UPS.

Table 1. BPM Positions

Switch Position	Description	
UPS	The normal operating state of the system occurs when the BPM switch is in the UPS position. Utility power is fed to the bypass, where power is then fed to the UPS. The UPS provides critical battery backup and power conditioning and power is then fed back to the bypass switch and then the critical load.	<p style="text-align: center;">UPS MODE</p>
LINE	When the switch is in the LINE position, utility power is directly connected to the critical load and the output of the UPS is disconnected. In this state the UPS remains powered, which is often beneficial for troubleshooting, obtaining logs, or updating firmware.	<p style="text-align: center;">LINE MODE</p>
SERVICE	Like the LINE position, the SERVICE position connects the load directly to AC input power and disconnects UPS output; however, because SERVICE also disconnects AC input from the UPS, this is the appropriate position for UPS maintenance or repair. In the SERVICE position, the UPS can be completely removed from the system.	<p style="text-align: center;">SERVICE MODE</p>

Chapter 2 Installation

This chapter explains:

- Dimensions
- Rack Installation
- Wallmount Installation
- Input Current and Wiring Ratings
- Signal Wire Routing

 **WARNING**

Risk of electrical shock. Only qualified service personnel (such as a licensed electrician) should perform the electrical installation.

 **CAUTION**

To prevent electrical shock or damage to the equipment, verify that the Eaton UPS is OFF before you remove the entrance panel. The circuit breaker or disconnect switch must also be off at the AC input service panel. Also, turn OFF the AC disconnect and bypass switches before you connect any wires to the bypass switch terminal strip.

Bypass Power Module Dimensions

Figure 1 shows the dimensions of the Bypass Power Module (BPM) in millimeters (inches).

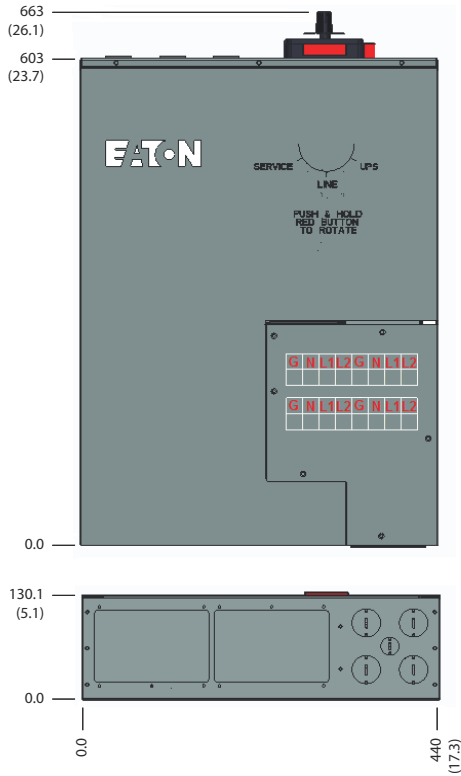

Figure 1. BPM Dimensions (in millimeters)

Rackmount Installation

125A BPM Rackmount Hardwired Installation

CAUTION

- The BPM distributes high density power in a small form factor.
 - Read the complete installation procedure before beginning any electrical wiring.
-

To install the BPM in a rack:

1. Install the 4-post rail kit included with the BPM (see Figure 2).

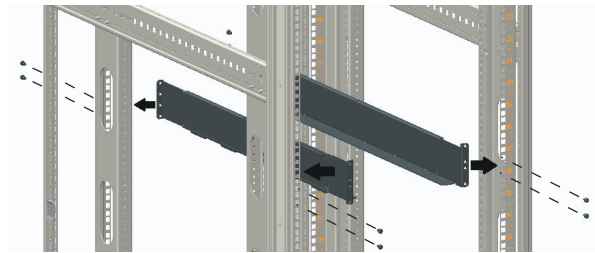

Figure 2. Install Rail Kit

2. Place the BPM on the rails and push the BPM into the rack.
Verify that the breakers are facing the front of the rack and the BPM wiring terminals are facing the rear of the rack.
3. Push the BPM past the back of the rack to allow access to the rear wire access-point covers and the wire access panel cover (see Figure 3).

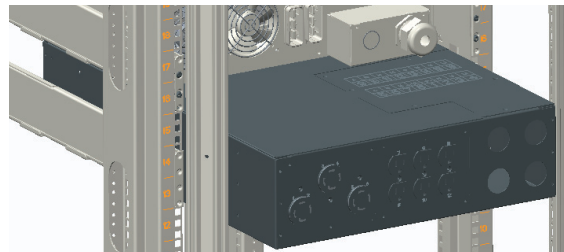

Figure 3. Push BPM into the Rack

4. Remove the wire access-point covers (see Figure 4).



Figure 4. Remove the Wire Access-Point Covers

5. Remove the access panel cover (see Figure 5).

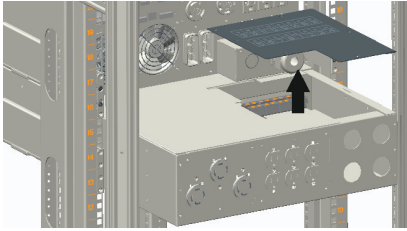

Figure 5. Remove the Access Panel Cover

6. To wire the BPM, see “Signal Wire Routing” on page 11.
7. After wiring is complete, replace the covers removed in Step 4 and Step 5.
8. Push the BPM past the front of the rack to allow access for the mounting ears installation.
9. Install the mounting ears to the BPM using the provided screws (see Figure 6).

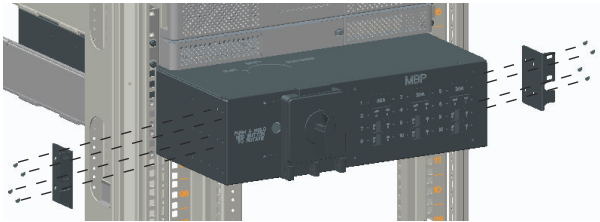

Figure 6. Install the Mounting Ears

10. Push the BPM into the rack and secure the mounting ears to the rack using the provided screws (see Figure 7).

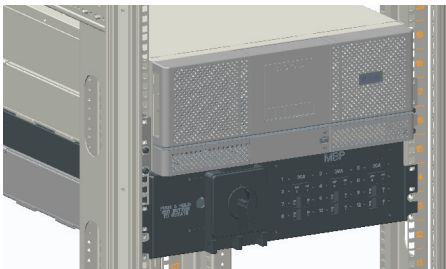

Figure 7. Secure the BPM to the Rack

30A Linecord Input BPM Rackmount Installation

CAUTION

- The BPM distributes high density power in a small form factor.
 - Read the complete installation procedure before beginning any electrical wiring.
-

To install the BPM in a rack:

1. Install the 4-post rail kit included with the BPM (see Figure 8).

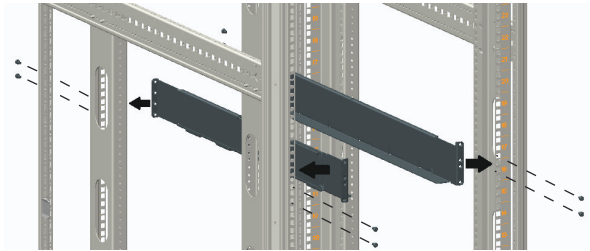

Figure 8. Install Rail Kit

2. Place the BPM on the rails and push the BPM into the rack, leaving enough room to allow access for the mounting ears installation.

Verify that the breakers are facing the front of the rack and the BPM wiring terminals are facing the rear of the rack.

3. Install the mounting ears to the BPM using the provided screws (see Figure 9).



Figure 9. Install the Mounting Ears

4. Push the BPM into the rack and secure the mounting ears to the rack using the provided screws (see Figure 10).

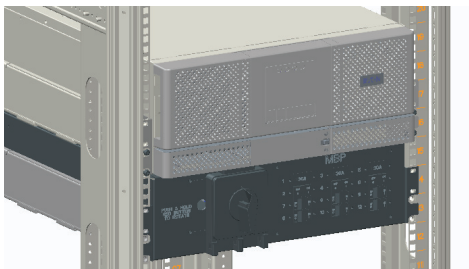

Figure 10. Secure the BPM to the Rack

5. Remove the knockouts in the bottom of the BPM as needed for wiring.

6. To wire the BPM, see “Signal Wire Routing” on page 11.
7. Connect the UPS to the BPM as shown in Figure 11

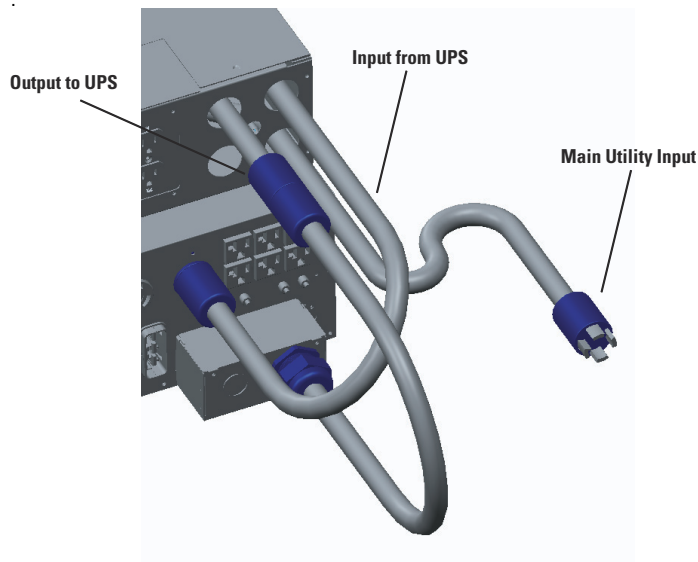

Figure 11. Connect the UPS to the BPM

Wallmount Installation

Wallmount Hardwired BPM Installation

CAUTION

- The BPM distributes high density power in a small form factor.
 - Read the complete installation procedure before beginning any electrical wiring.
-

To install the BPM in a wallmount form factor:

1. Select a mounting location for the bypass switch within sight of the UPS.



NOTE

The bypass switch should be mounted securely to a sturdy surface. You may need to turn the cabinet 90 degrees (on its side) to enable operator access to the switch handle.

2. Use the provided wallmount brackets to firmly secure the BPM to the wall (Figure 12).

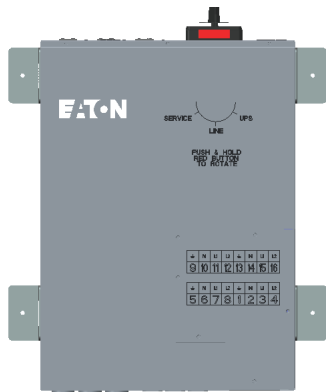

Figure 12. BPM with Wallmount Brackets

3. Remove the six (6) screws on the BPM front cover and remove the cover. Remove any packing material inside the BPM.
4. Remove the knockouts in the bottom of the BPM as needed for wiring (see Figure 13).

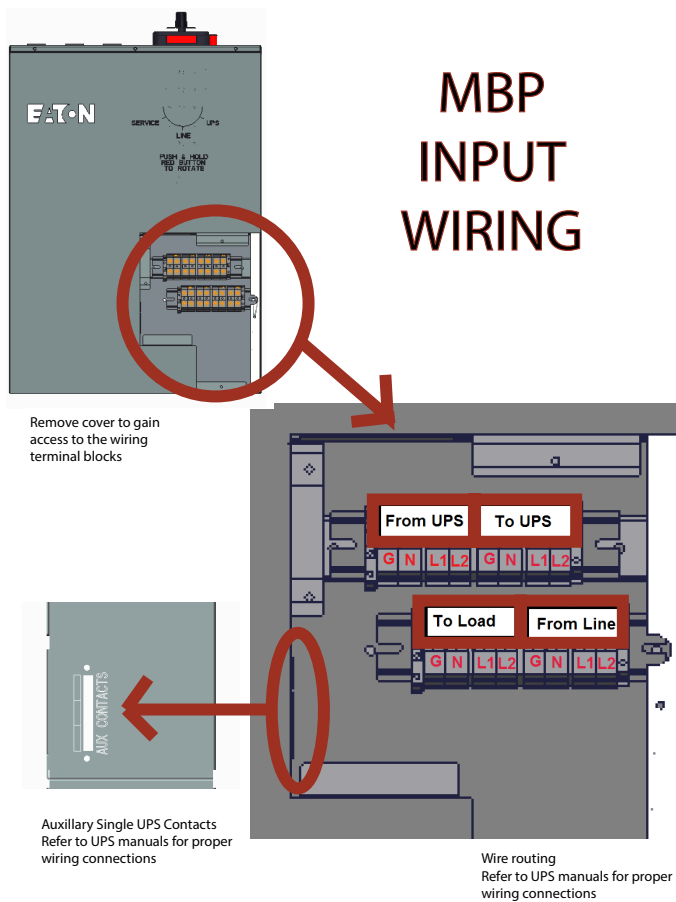

Figure 13. BPM Hardwired Overview

5. To wire the BPM, see “Signal Wire Routing” on page 11.
6. After wiring is complete, replace the cover removed in Step 3.

30A Wallmount Linecord BPM Installation

 **CAUTION**

- The BPM distributes high density power in a small form factor.
 - Read the complete installation procedure before beginning any electrical wiring.
-

To install the BPM in a wallmount form factor:

1. Select a mounting location for the bypass switch within sight of the UPS.



NOTE The bypass switch should be mounted securely to a sturdy surface. You may need to turn the cabinet 90 degrees (on its side) to enable operator access to the switch handle.

2. Use the provided wallmount brackets to firmly secure the BPM to the wall (Figure 14).

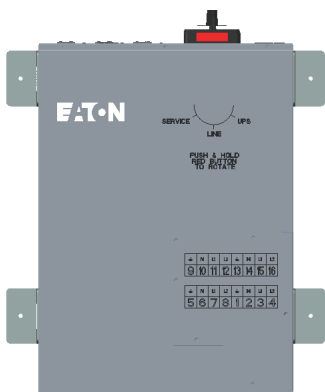

Figure 14. BPM with Wallmount Brackets

3. Use the provided wallmount brackets to firmly secure the BPM to the wall.
4. Remove the six (6) screws on the BPM front cover and remove the cover. Remove any packing material inside the BPM.
5. Remove the knockouts in the bottom of the BPM as needed for wiring.
6. To wire the BPM, see “Signal Wire Routing” on page 11.
7. After wiring is complete, replace the cover removed in Step 4.

Input Current and Wire Ratings

Wiring to the BPM varies based on the UPS selection. Refer to the UPS manual for recommended input breaker size. To easily expand the system, it is recommended that initial installation of the BPM and UPS contains wiring to support the maximum capacity of the UPS system. For example, if the UPS is now designed to be a 12 kVA system with an 80A input, but can be expanded to 18 kVA requiring 125A input in the future, then 125A wiring would be used initially to prevent rewiring costs during future expansion.

Local electrical codes should always be followed, but be sure to check with the terminal block sizing on both the UPS and the BPM. The UPS terminal block sizing can be found in the UPS manual, while the BPM terminal block sizing can be found in Table 2.

Table 2. RBPM Terminal Block Sizing

BPM Terminal Block Sizing	75°C Copper Wire Size	Conductor Screw Torque	Wire Size Range
BPM 125A Models	42.1 mm ² (1 AWG)	6.6 Nm (50 lb in)	10 - 1/0 AWG
BPM 30A Models	8.4 mm ² (8 AWG)	4.5 Nm (40 lb in)	14 - 6 AWG



IMPORTANT

FOR U.S. INSTALLATIONS, READ THIS IMPORTANT NOTE

- Table 2 lists the mm² and AWG wire size for each circuit breaker size shown on the wiring diagrams. The minimum recommended circuit breaker sizes for each model and voltage application are listed on the wiring diagrams.
- Conductor sizes shall be no smaller than the 75°C wire size based on the ampacities given in Table 310–16 of the National Electrical Code® (NEC®), ANSI/NFPA 70-1999, and article 220. All circuit conductors, including the neutral conductor, must be the same size (ampacity) wire. Code may require a larger AWG size than shown in this table because of temperature, number of conductors in the conduit, or long service runs. Follow local code requirements.

Signal Wire Routing



CAUTION

The auxiliary contacts must be wired to the BPM from the UPS for proper functionality. These auxiliary contacts signal the UPS to go to Internal Bypass mode to provide a synchronized transfer. Failure to wire the auxiliary contacts can be dangerous and result in system failure.

NOTE 1 Refer to the UPS manual and “Input Current and Wire Ratings” on page 11 for breaker, terminal block, and wire sizing.



NOTE 2 Provide enough flexibility in the conduit for the BPM to be firmly mounted in the rack (see step 7, Figure 9).

NOTE 3 Connection diagrams can be found on pages 9-11 for wiring details.

To route signal wires (customer supplied):

1. Route the signal wires through the provided insulation.
2. Pass the insulated wires through the opening in the rear panel (Figure 15).
3. Connect terminal blocks to signal wires.
4. Plug in the terminal blocks into their proper locations.

Connection Diagrams

9155 UPS to BPM Connection Diagram

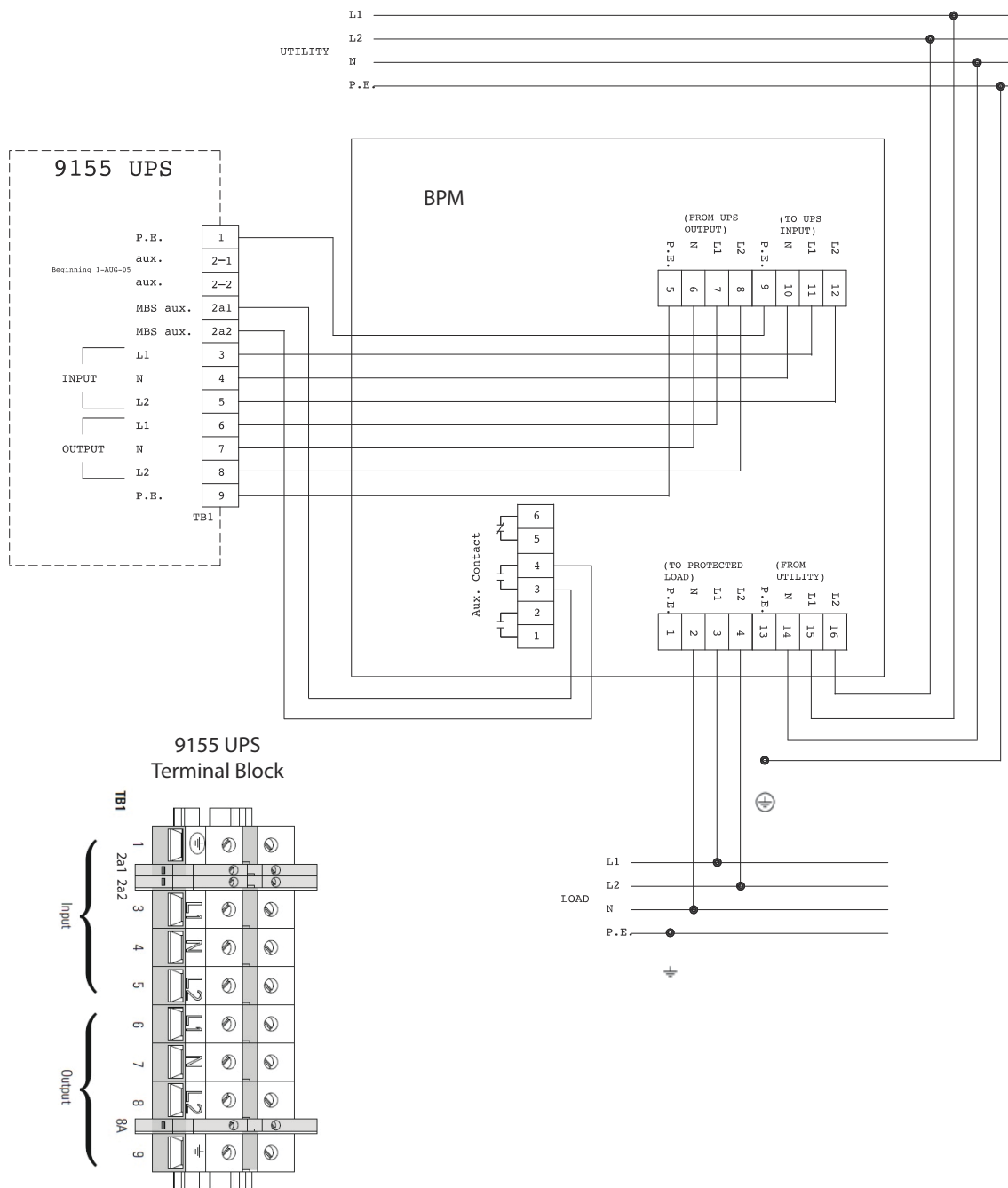

Figure 16. Eaton 9155 UPS to BPM Connection Diagram

9170+ UPS to BPM Connection Diagram

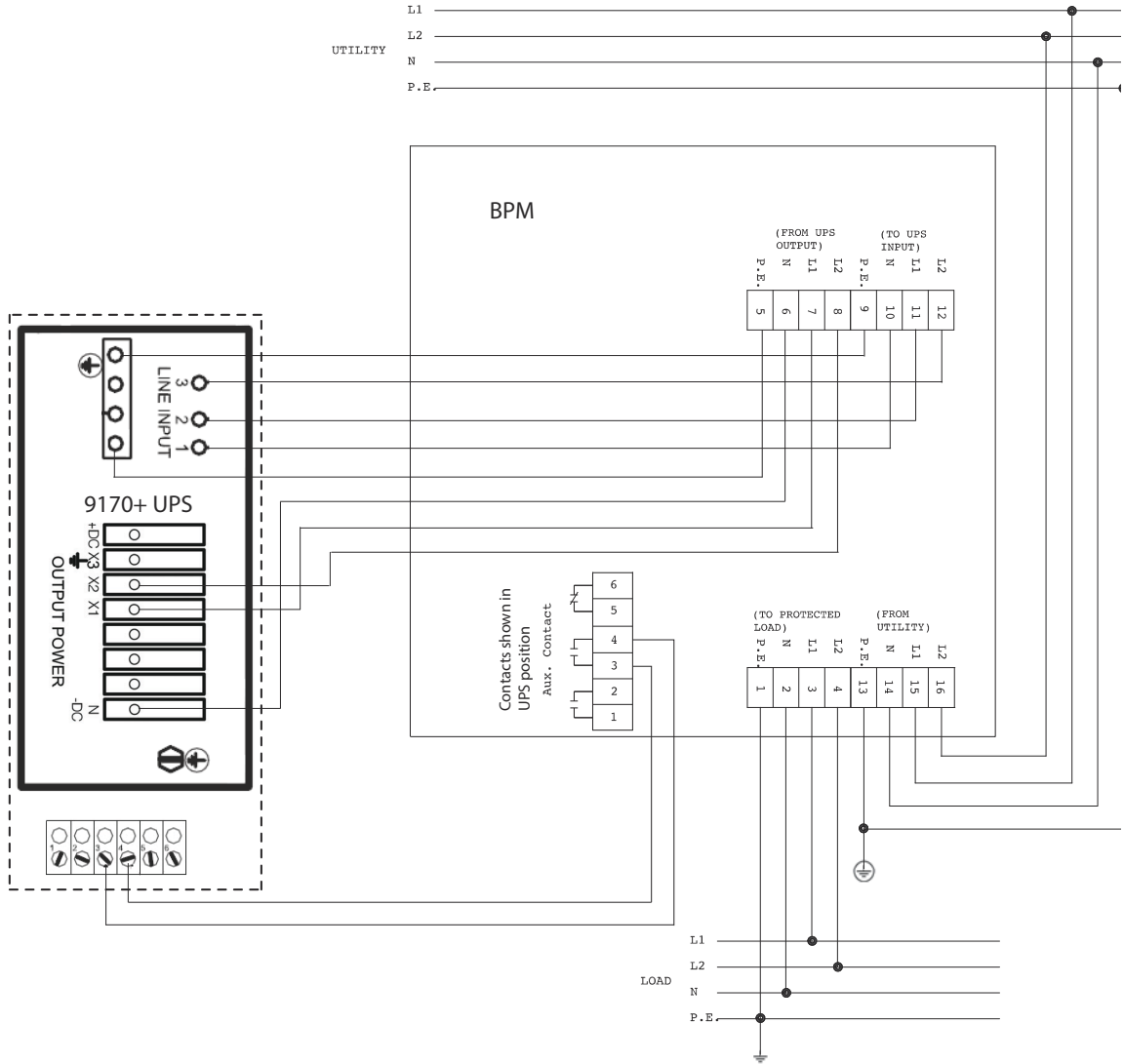

Figure 17. Eaton 9170+ UPS to BPM Connection Diagram

9PXSP UPS to BPM Connection Diagram

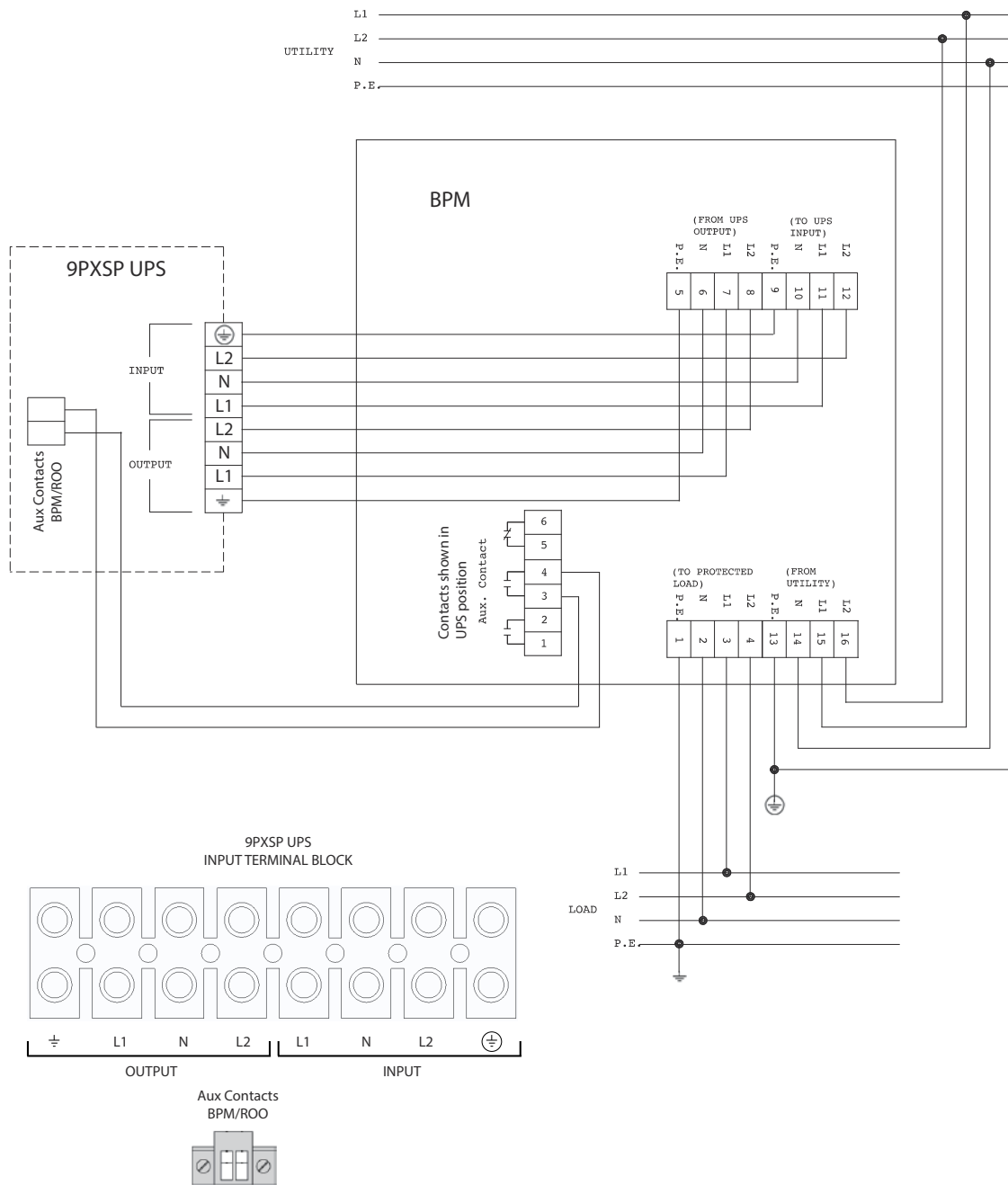

Figure 18. Eaton 9PX SP UPS to BPM Connection Diagram

This page intentionally left blank.

Chapter 3 Operation

This chapter contains information for operating the Bypass Power Module (BPM).

No Break Transfer from UPS Mode to Service Mode

CAUTION

It is critical that the following steps are followed to ensure correct and safe operation.

To turn the BPM to SERVICE:

1. Press and hold the red button and turn the switch to LINE (see Figure 19).



NOTE

Pressing the red button sends the UPS into Internal Bypass mode. This allows the UPS output to synchronize with utility for safe, uninterrupted transfer.

The UPS is now in LINE mode. The critical load is fed directly from utility and the UPS remains energized from utility power. The UPS may be left in this mode while trying to troubleshoot, gather alarms from the UPS, or perform other preventative maintenance activities.

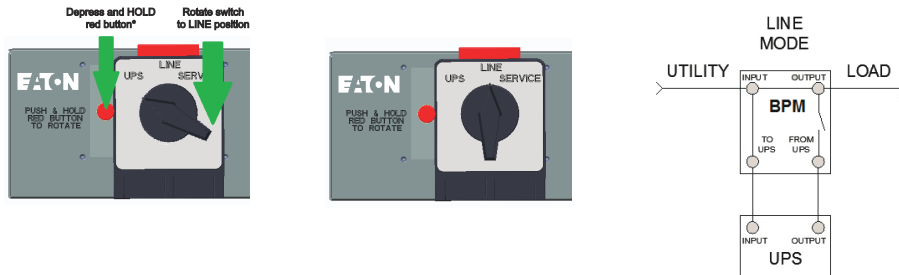

Figure 19. From UPS to LINE

2. Turn the switch from LINE to SERVICE (see Figure 20). The critical load is fed directly from utility and the UPS is now completely disconnected from AC power. Ensure that the UPS is off and the terminals are completely de-energized before performing any maintenance on the UPS.

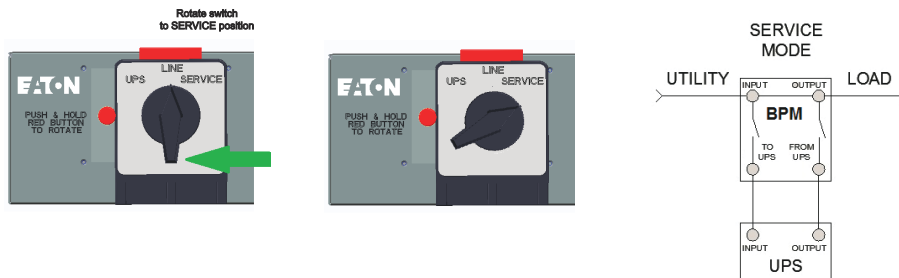

Figure 20. From LINE to SERVICE

Lock-out/Tag-out

The BPM comes with a Lock-out/Tag-out (LOTO) feature to keep the BPM bypass switch locked in SERVICE mode while qualified service personnel works on the UPS. To use the LOTO feature:

1. Press and hold the red bar (see Figure 19).

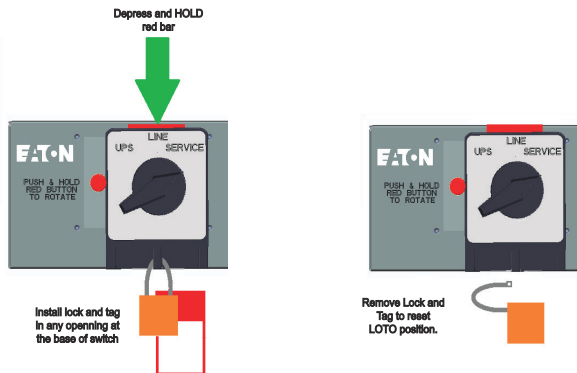

Figure 21. LOTO Feature

2. Install a lock and tag in any opening at the base of the switch according to LOTO procedures.
3. Remove the lock and tag to reset the LOTO position.

No Break Transfer from Service Bypass to UPS Mode

After the system has been placed into SERVICE mode, it must be returned to UPS state to resume normal operation.

CAUTION

It is critical that the following steps are followed to ensure correct and safe operation.

To turn the BPM to UPS mode:

1. Turn the switch from SERVICE to LINE (see Figure 22).

The UPS is now in LINE mode and is energized. It is often best practice to check the UPS status and configure settings in this mode before transitioning to UPS mode. Simply check the status of the UPS through the front LCD menu to ensure the UPS is prepared for use.



Figure 22. From SERVICE to LINE

2. To transition the UPS from LINE to UPS, press and hold the red button and turn the switch to UPS (see Figure 23).

NOTE 1 Pressing the red button sends the UPS into Internal Bypass mode. This allows the UPS output to synchronize with utility for safe, uninterrupted transfer.



NOTE 2 In UPS mode, the UPS resets from Internal Bypass to UPS Normal mode (online mode). This transition may take as long as 60 seconds.

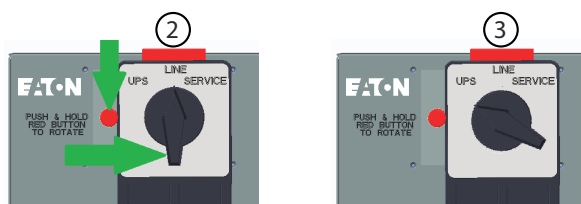

Figure 23. From LINE to UPS

3. Once the switch is in UPS mode and the UPS is in Normal mode (online mode), the system is in normal operation and prepared to provide uninterrupted power to the critical load.

Chapter 4 Specifications

This chapter provides the following specifications:

- Dimensions and weights
- Electrical connections
- Rear Panel Outlet Options

Table 3.

Model	Dimensions HXWXD (mm/inch)	Weight (kg/lb)
BPM30XX	130 x 440 x 663 / 5.1 x 17.3 x 26.1	15/34
BPM125XX	130 x 440 x 663 / 5.1 x 17.3 x 26.1	17/38

Table 4.

Model	Input Connection
BPM30XX	L14-30 or Hardwired (L1, L2, N, G)
BPM125XX	Hardwired (L1, L2, N, G)

Rear Panel Outlet Options

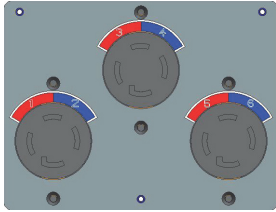

L14-30R

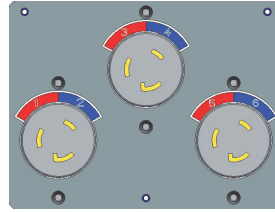

L6-20R

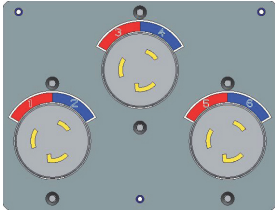

L6-30R

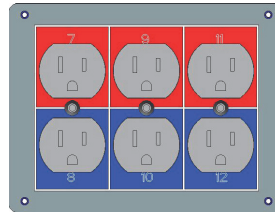

5-20R



C19



Blank

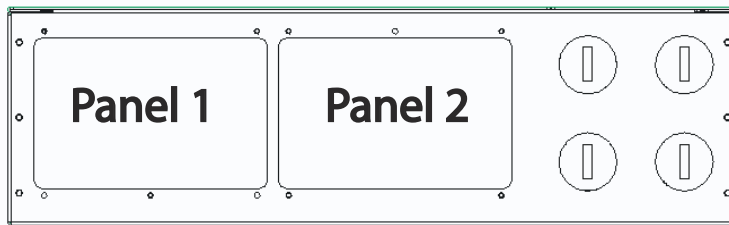

P-164000628 2

P-164000628 2